

# STORM 1200x

## Product Manual

English

# Table of Contents

Introduction .....	04
Components List.....	05
Product Overview.....	06
1.Lamp Head.....	06
2.Control Box.....	06
Setup .....	07
1.Attaching/Detaching the Protection Cover.....	07
2.Attaching/Detaching the Reflector.....	07
3.Setting Up the Lamp Head.....	07
4.Using the Lightning Clamp .....	08
5.Connecting the Lamp Head to the Control Box .....	09
6.Powering Up the Control Box .....	10
Operating Instructions.....	11
1. Powering On/Off.....	11
1.1 Status Indicator Icons.....	11
2. Manual Control of Control Box.....	12
2.1 MENU.....	12
2.2 Accessing Lighting Modes.....	12
2.2.1 CCT Mode .....	13
2.2.2 xy Mode .....	13
2.2.3 FX Mode.....	13
2.2.4 SidusFX Mode.....	14
2.3 Control Settings .....	14
2.3.1 DMX Settings.....	15
2.3.2 CRMX Settings.....	16
2.3.3 Sidus BT Settings .....	19
2.3.4 Ethernet Settings .....	20
2.4 System Settings .....	24
2.4.1 Dimming Curve .....	24
2.4.2 Output Settings.....	25

2.4.3 White Light Standard.....	25
2.4.4 Lead/Follow Mode .....	25
2.4.5 High-Speed Mode .....	25
2.4.6 Fan Mode.....	26
2.4.7 Studio Mode.....	27
2.4.8 Screensaver.....	27
2.4.9 Language .....	27
2.4.10 Product Information .....	27
2.4.11 Firmware Update .....	28
2.4.12 Factory Reset .....	29
2.5 Presets.....	30
3.Control with a DMX Console.....	30
4.Controlling via DMX .....	31
5.Sidus Link Pro and Sidus Link .....	31
Product Specifications .....	32
Photometrics.....	33
Safety Instructions.....	37
FCC Compliance Statement .....	39
Disclaimer .....	40

# Introduction

Thank you for purchasing the Aputure® "STORM" series tunable white STORM 1200x. The STORM 1200x is a high power tunable white light source with fully adjustable CCT (2500K-10,000K). It supports CCT (with  $\pm G$  adjustment) and xy control. Professional control protocols are supported, such as DMX512-A, Lumen Radio CRMX, RDM, Art-Net, and sACN, as well as Sidus BT from Aputure. With an IP65 rating and standard Bowens Mount and Spotlight MAX compatibility, the STORM 1200x is a powerful, professional lighting solution with industry standard controls unlocking unprecedented creative freedom.

# Components List

Before using this product, please check that all of the following items are included in the package. If any are missing, please contact your dealer.

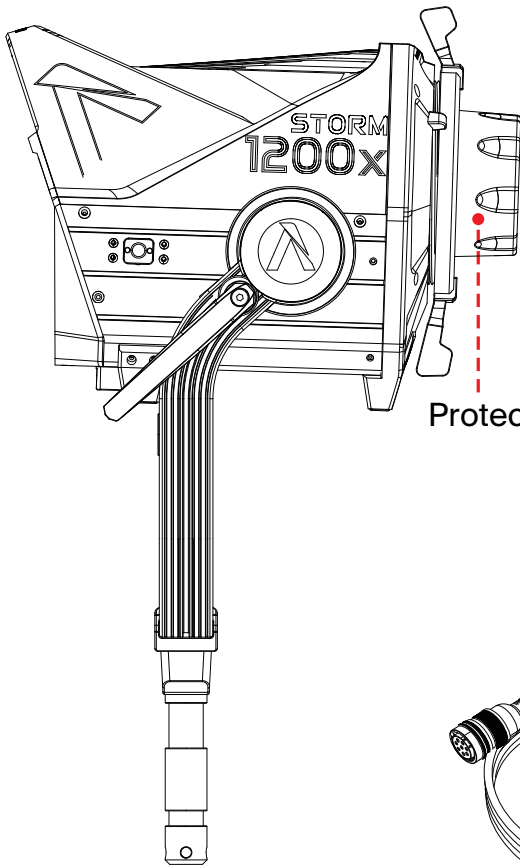

Protection Cover x 1

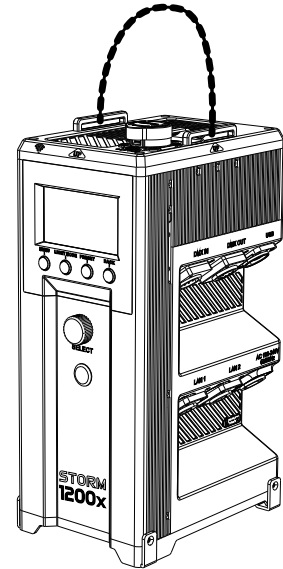

STORM 1200x  
Control Box

STORM 1200x  
Lamp Head x 1

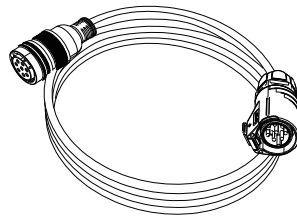

7.5m 8-pin Head Cable x 1

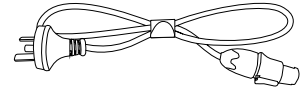

Neutrik® power CON  
AC Power Cable (6m) x 1

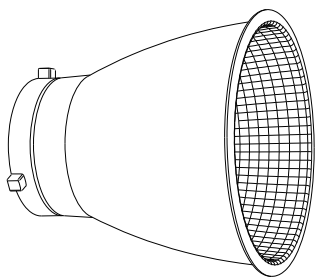

Wide Angle Reflector x 1

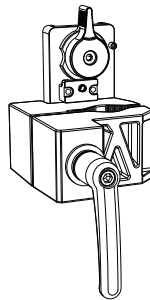

Lightning Clamp x 1

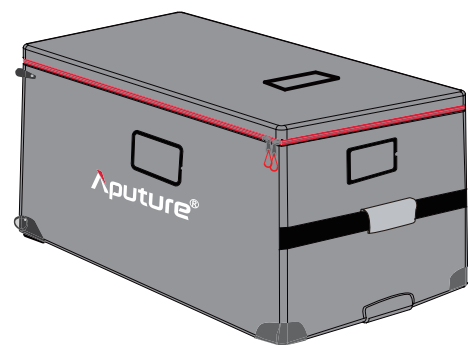

Carrying bag x 1

*\* All illustrations in this manual are for reference only. Plug specifications vary per region. The physical product may also differ from the schematic diagram due to continuous updates and upgrades.*

# Product Overview

## 1. Lamp Head

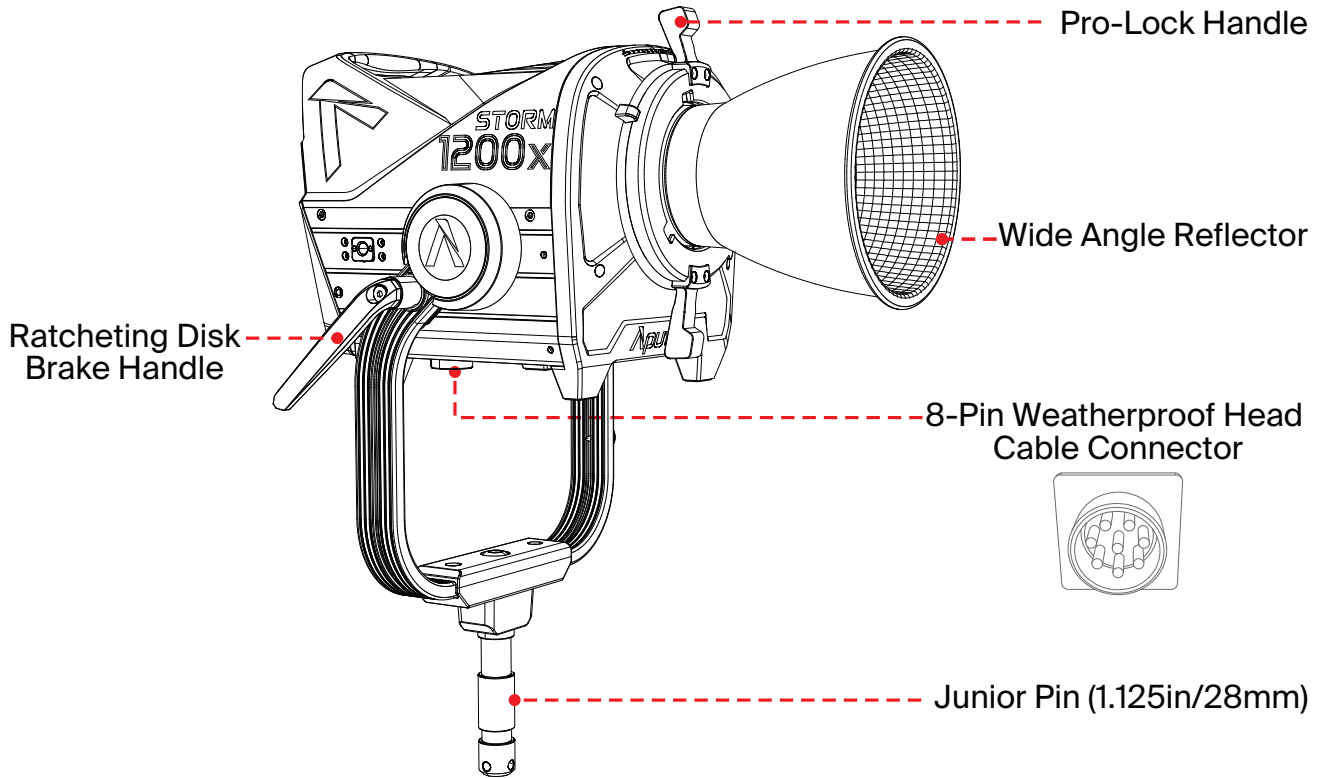

## 2. Control Box

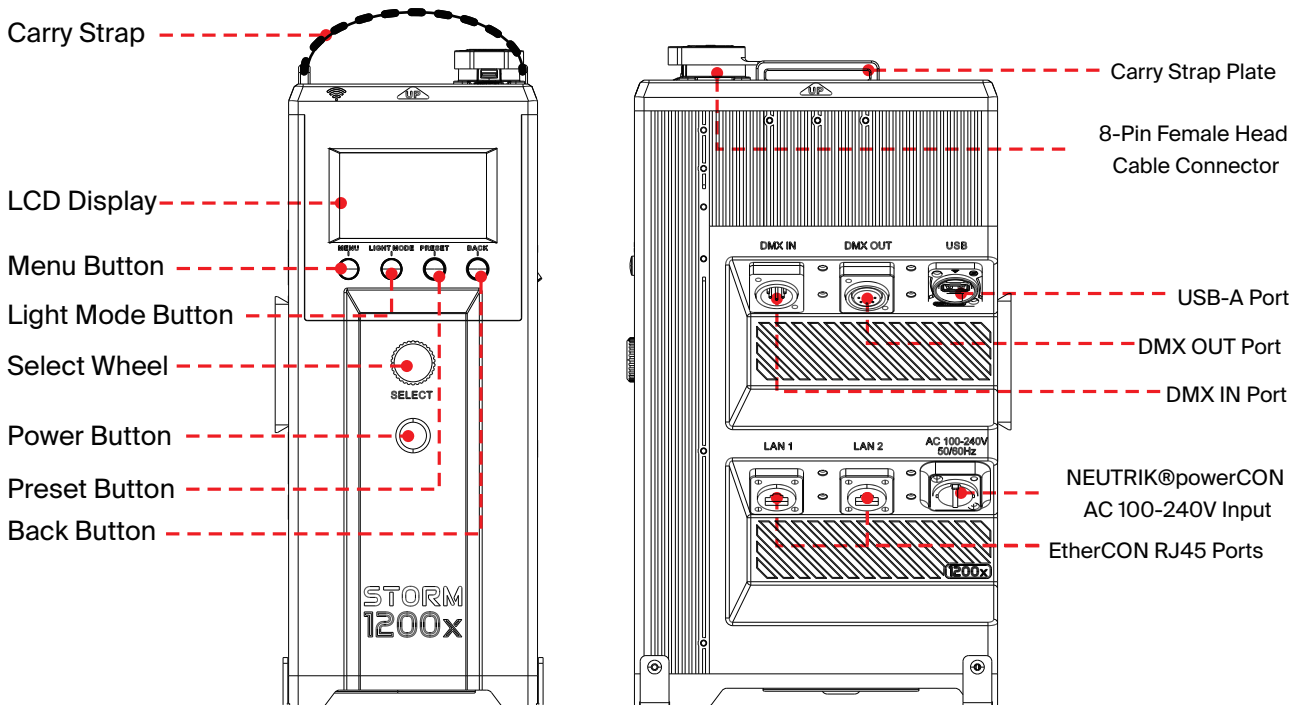

# Setup

## 1. Attaching/Detaching the Protection Cover

To detach the cover, rotate the Pro-Lock Handle to the open position and remove it. To reattach the cover, insert it into place and rotate the Pro-Lock Handle clockwise until locked.

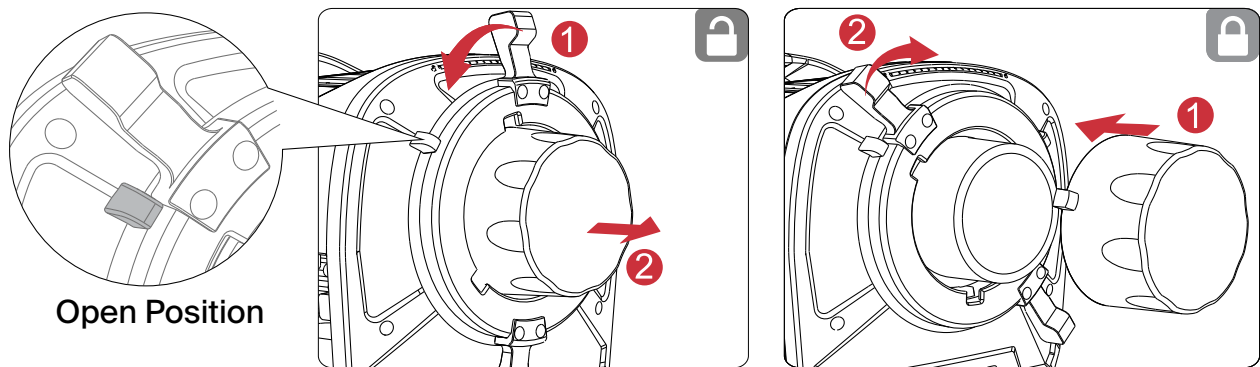

\* Before use, please make sure to remove the protective cover. During transportation and storage, please attach the protective cover.

## 2. Attaching/Detaching the Reflector

To attach the Reflector, insert it into the Bowen Bayonet Mount and rotate the Pro-Lock Handle clockwise until locked. To detach the Reflector, rotate the Pro-Lock Handle to the open position and remove it.

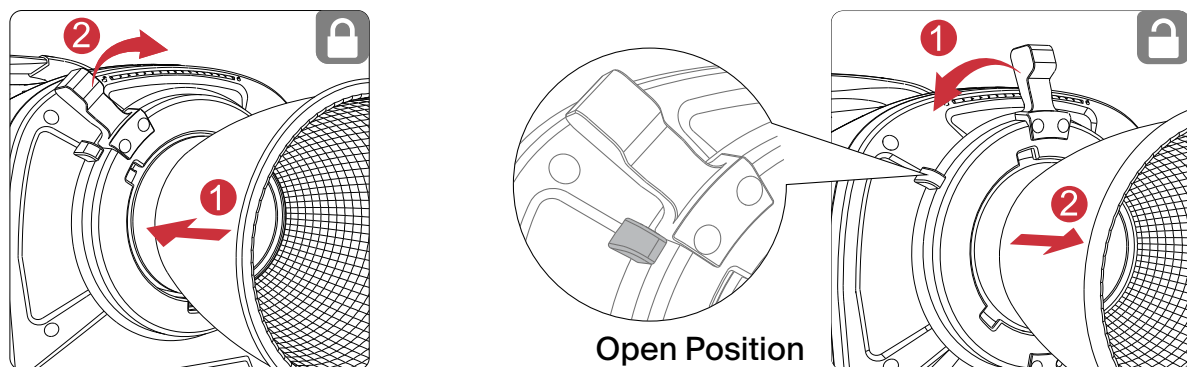

Installation of a Reflector

Reflector removal

## 3. Setting Up the Lamp Head

Mount the Lamp Head into a Junior Receiver and tighten in place. Loosen or tighten the disc brake handle on the yoke to adjust the fixture's angle of tilt.

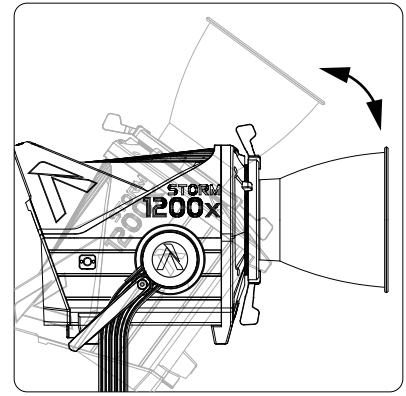
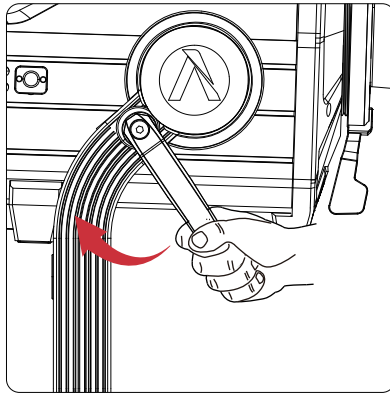
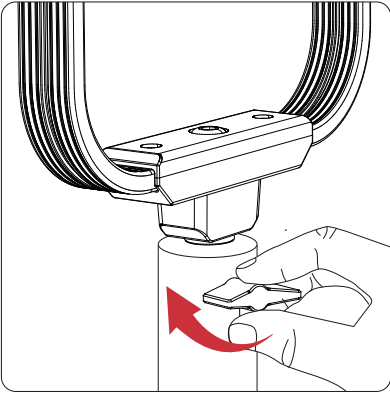

## 4. Using the Lightning Clamp

- 1) Attach the Lightning Clamp onto a light stand.
- 2) To attach the Control Box, rotate the release lever to unlock the quick-release plate. Then mount the Control Box onto the Lightning Clamp (the release lever will spring back) and check that it is secure.

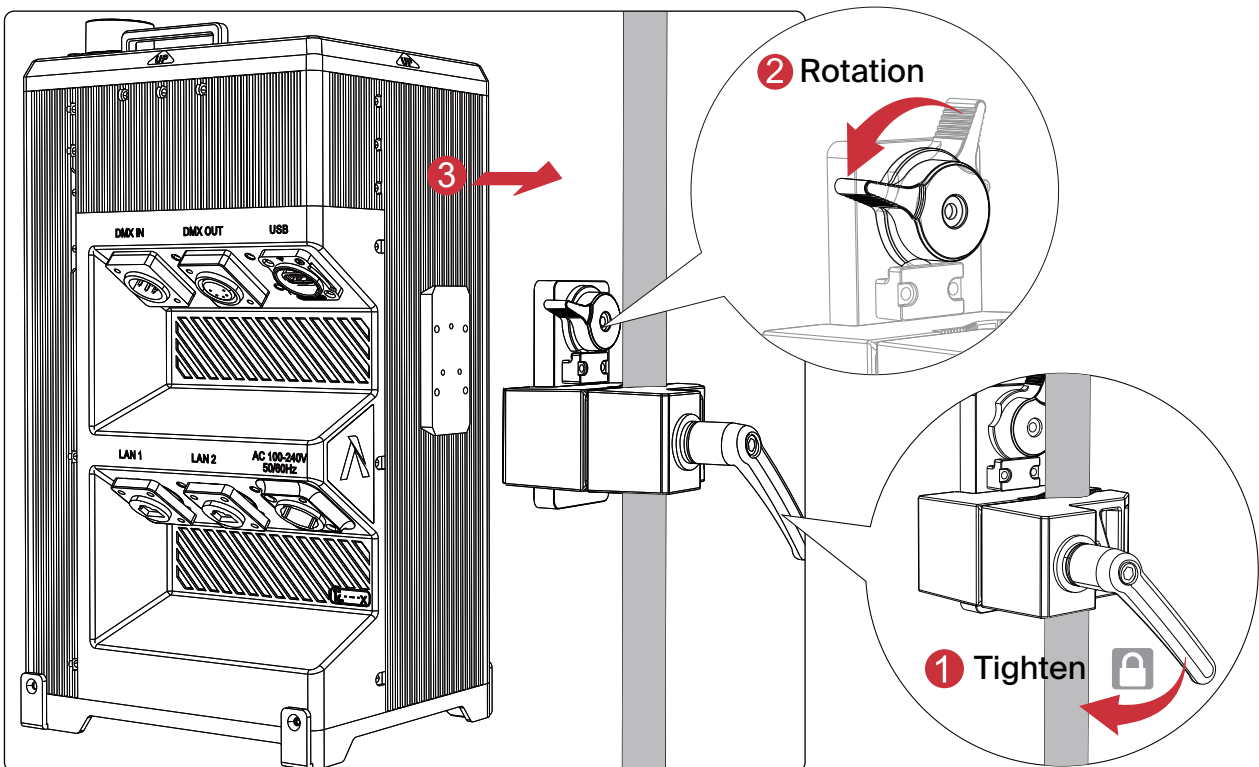



3) To remove the Control Box, grasp it firmly, and unlock the quick-release plate by turning its lever.

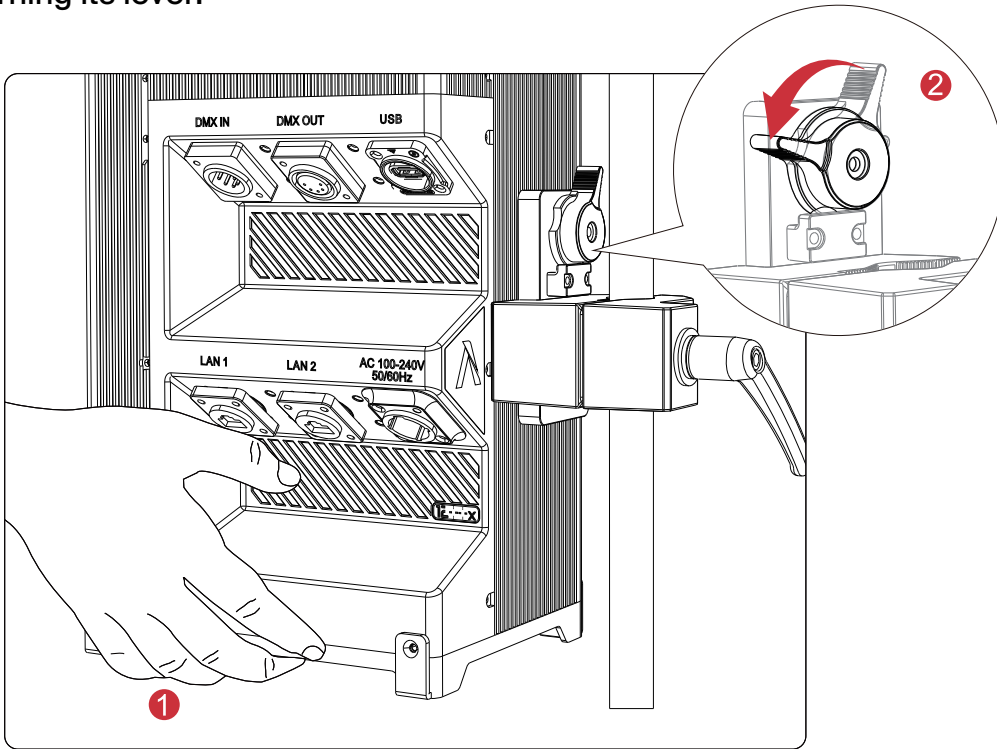

\* The Lightning Clamp can attach to round or square fittings with a diameter of 2-5cm / 0.79-1.97 in.

## 5. Connecting the Lamp Head to the Control Box

Connect the Lamp Head to the Control Box using the 8-pin Weatherproof Head Cable.

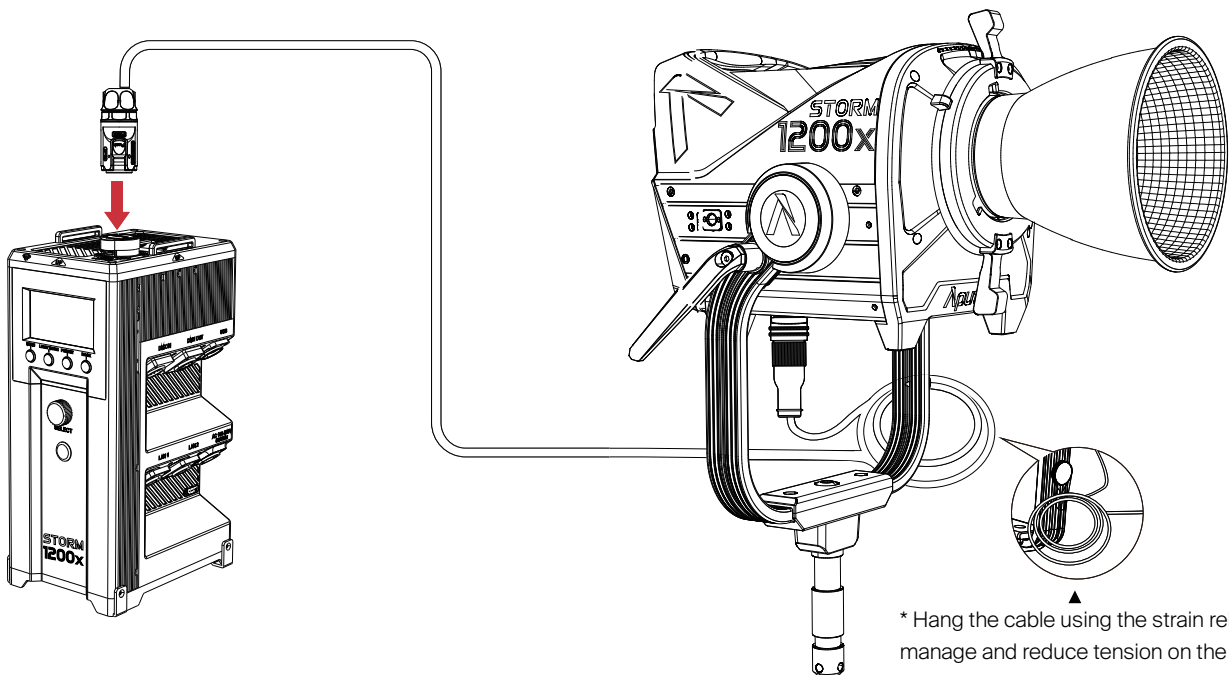

\* Hang the cable using the strain relief to manage and reduce tension on the cable.

## 6. Powering Up the Control Box

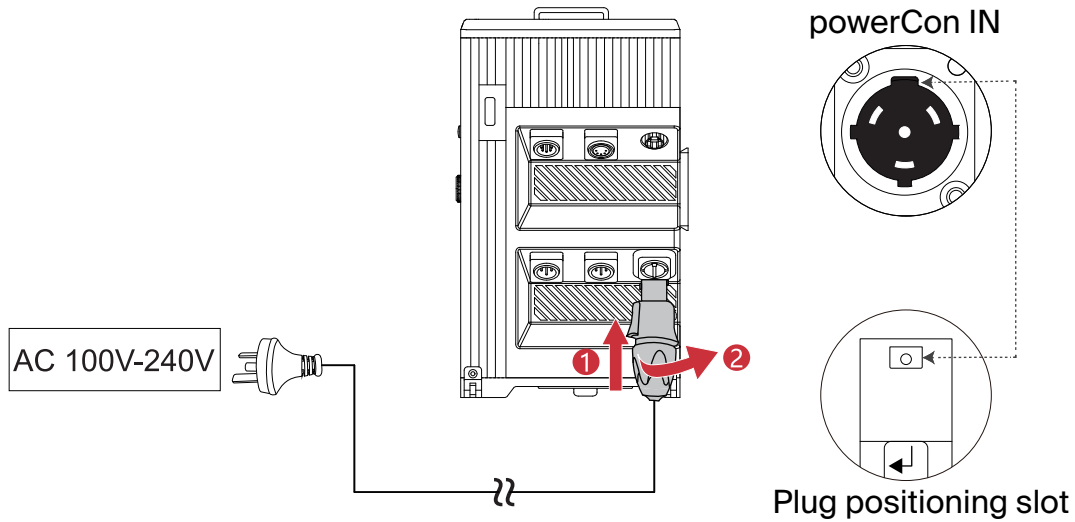

*\*To disconnect the Neutrik® powerCon cable, pull back on the silver release tab on the cable connector, and rotate the connector counter clockwise. Do not pull directly on the cable.*

# Operating Instructions

## 1. Powering On/Off

Connect the power supply and press the power button on the Control Box to turn on/off.

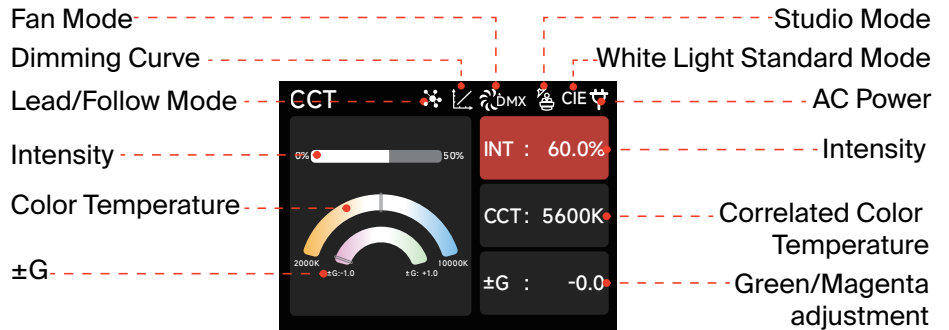
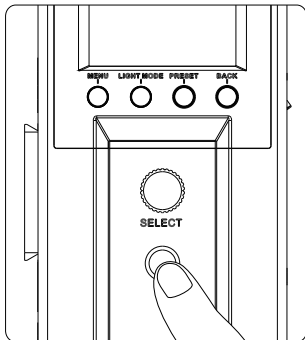

*Note: If your fixture has Studio Mode "ON": the Control Box will power on whenever power is supplied to it.*

### 1.1 Status Indicator Icons

Lead/Follow Mode: Leader		Sidus BT Enabled	
Lead/Follow Mode: Follower		Receiving CRMX data	
Fan Mode: Silent		CRMX connected, no DMX data	
Fan Mode: High		Connected to CRMX, no transmitter found	
Fan Mode: Medium		Ethernet	
Fan Mode: Smart		AC Power Detected	
Fan Mode: DMX		CIE Daylight	
Dimming Curve: Linear		Blackbody	
Dimming Curve: S-Curve		Studio Mode: ON	
Dimming Curve: Exponential		Studio Mode: OFF	
Dimming Curve: Logarithmic		High-Speed Mode Enabled	

## 2. Manual Control of Control Box

Press the button on the Control Box to enter the corresponding modes: MENU, LIGHT MODE, and PRESET.

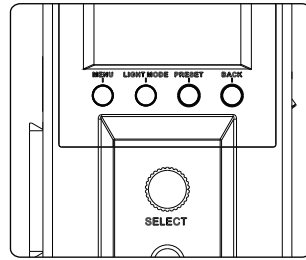

### 2.1 MENU

Press the MENU button to enter the System Menu interface. Choose between Light Mode, Control Settings or System Settings.

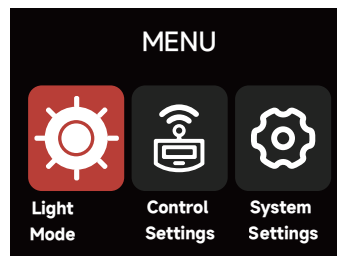

### 2.2 Accessing Lighting Modes

Press the Light Mode Button on the Control Box to enter the Light Mode interface. Choose between CCT, xy, FX, and Sidus FX Modes.

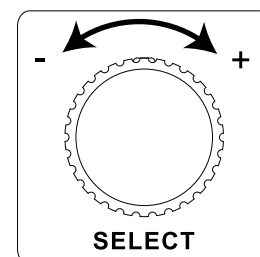
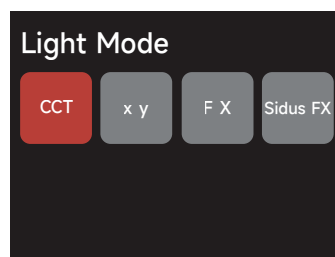

*\*Note: Light Modes can only be accessed when no DMX data is present. Please ensure that DMX data is not being listened to by the Control Box in order to use Light Modes.*

## 2.2.1 CCT Mode

Adjust the Color Temperature (2500K-10000K) and the  $\pm$ Green level (-1.00 through +1.00).

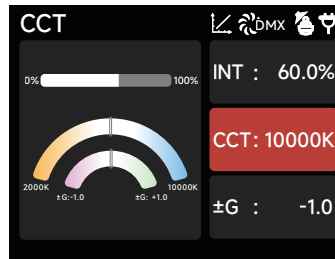

## 2.2.2 xy Mode

Set the x coordinate value (0.1550-0.6815) and y coordinate value (0.0300-0.5500) and the Intensity.



## 2.2.3 FX Mode

Select between FX modes: Fireworks / Explosions / Flames / Paparazzi / Defective Bulb / TV / Pulse / Flash/ Lightning.

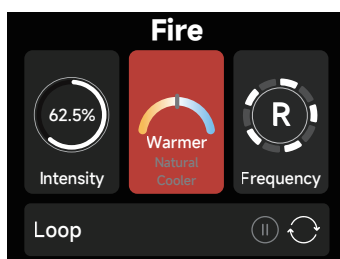
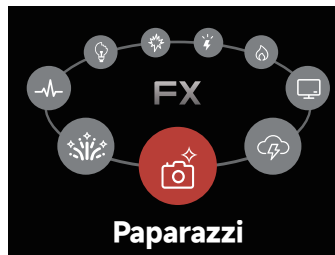

Flame Mode



Paparazzi Mode

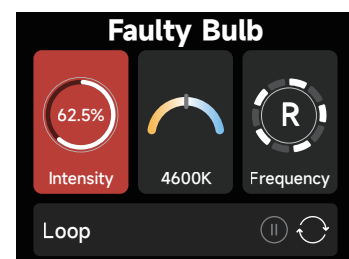

Faulty Bulb Mode

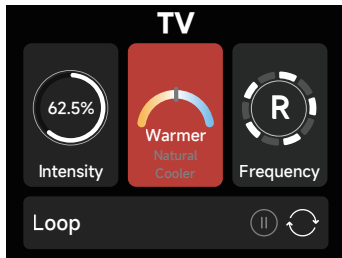

TV Mode

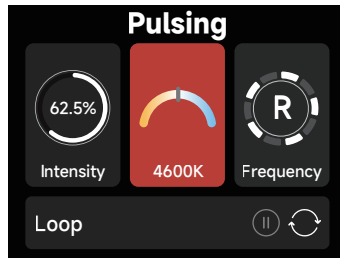

Pulse Mode

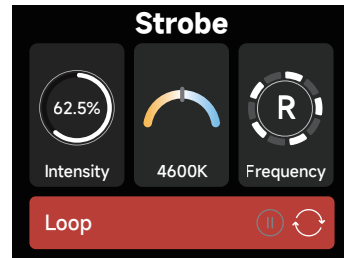

Flash Mode

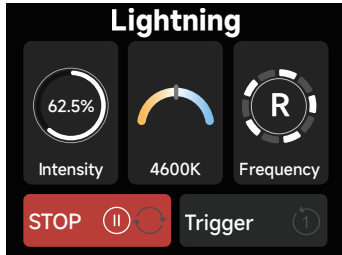

Lightning Mode

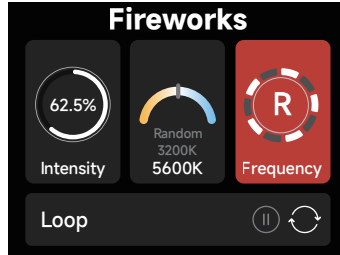

Fireworks Mode

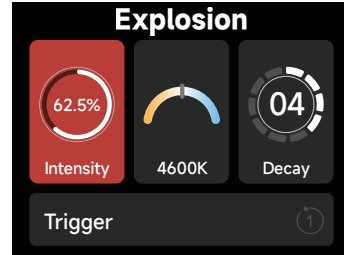

Explosion Mode

## 2.2.4 Sidus FX Mode

Select either Picker FX or Music FX. Both custom FX choices can save up to 10 FX. "NO FX" indicates that nothing has been saved to this slot. Untitled indicates that an effect has been saved to the slot. The two types of light effects can save 10 custom light effects each. The suffix "NO FX" indicates that no light effect has been saved.

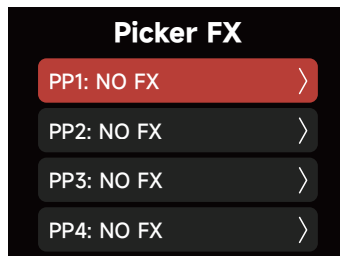
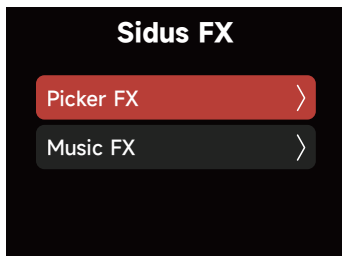

## 2.3 Control Settings

Choose between: DMX Settings, CRMX Settings, Sidus BT Settings and Ethernet Settings.

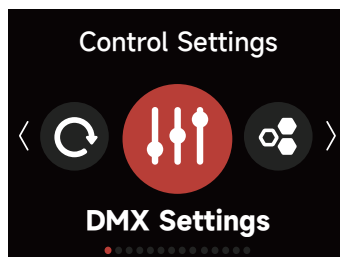

## 2.3.1 DMX Settings

(1) DMX Status Screen: Displays DMX data status, the DMX address, the DMX Profile being used, the CRMX Signal Strength, Fan Mode, Dimming Curve, Studio Mode in use, Output Mode, Power Status and more.

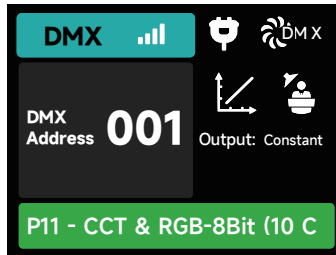

(2) DMX Address: Set the DMX address of this device.



(3) DMX Profile: Choose which DMX Profile to use. Refer to the DMX Chart for the specifics of each profile.

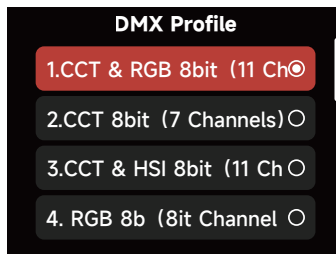

(4) DMX Loss Behavior--from the following options:

- I. Hold Last Look: when DMX signal is lost, DMX values will be retained until signal is regained.
- II. Black Out: when DMX signal is lost, the light will black out.
- III. Fade to Black: when DMX signal is lost, the light will wait for 60 seconds before fading to black.
- IV. Hold 2 min.&Fade Out: when DMX signal is lost, the DMX values are retained for two minutes before fading out over a time of 60 seconds.

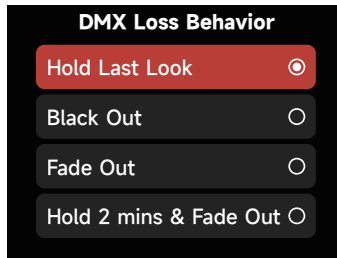

(5) DMX Smoothing: Set the smoothness of DMX dimming.

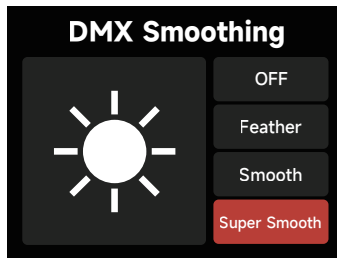

(6) DMX Termination: Turn ON (to help with DMX signal reflection) or OFF.

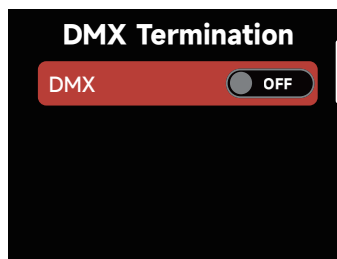

### 2. 3. 2 CRMX Settings

Turn CRMX ON or OFF.

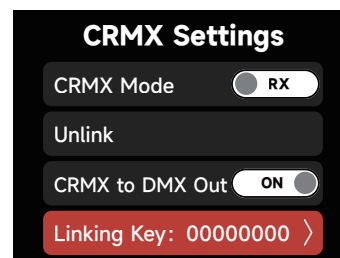
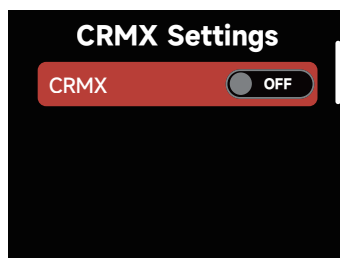

(1) When CRMX is ON/Enabled, the fixture will listen for it's previously linked Transmitter. If the fixture is currently unlinked, it will listen for a Transmitter link signal and link to any new CRMX link signal. Users can Unlink from previously linked Transmitters by selecting Unlink. Once a CRMX Link is established and DMX data is present, the display will change to the DMX Status Screen.



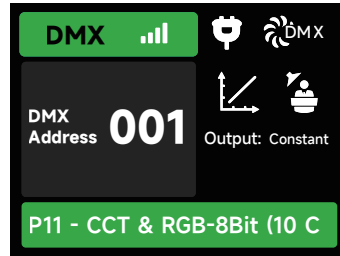
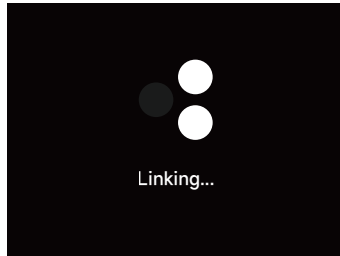

(2) When in CRMX RX Mode, CRMX to DMX512 "ON" pushes the received DMX data out of the DMX Out Port. If "OFF", then no data is pushed out of the DMX Out Port.

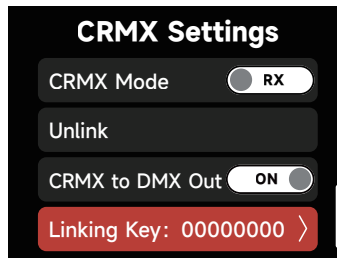

(3) When utilizing CRMX TX Mode, the Control Box can transmit DMX data to receivers using CRMX.

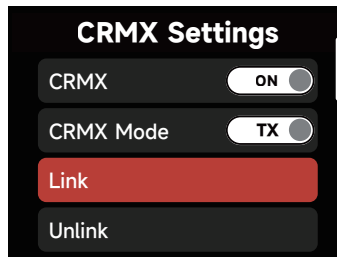

(4) While acting as a CRMX TX, the Control Box can have a Linking Key for RX's to link to.

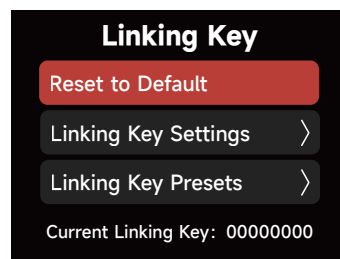
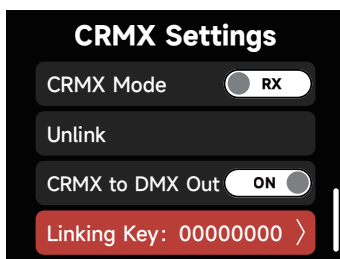

- a. In the Linking Key interface, choose an 8 digit number to be the Linking Key. Three digits cannot be "0".

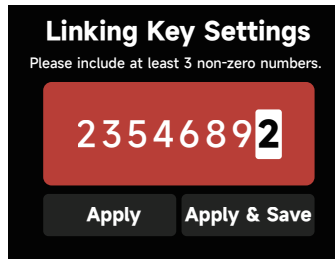

- b. Choosing "Apply" sets the Linking Key. Presets can be saved for future use by selecting "Apply & Save".

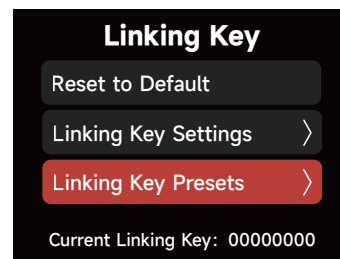
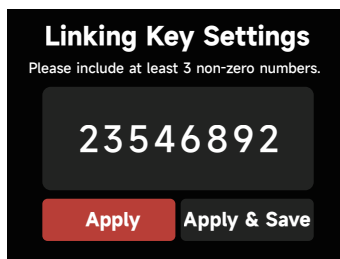

- c. Save 10 Presets in total.

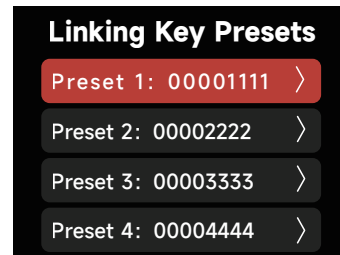
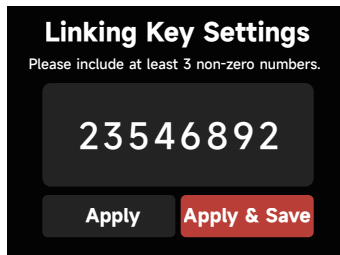

- d. In the Linking Key Preset interface, save up to 10 Presets by choosing "Save" or set the Control Box's Linking Key and save it as the selected Preset by choosing "Apply and Save".

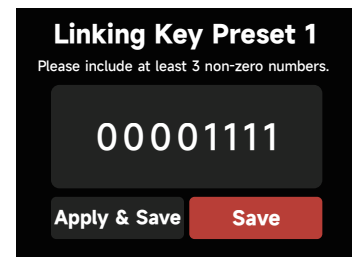
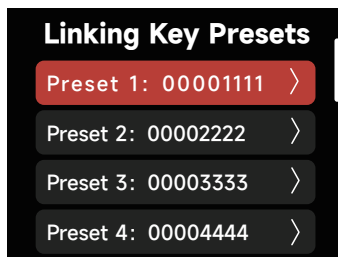
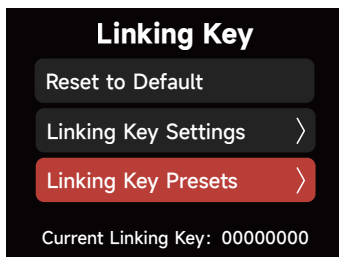

## (5) CRMX RX (Receiving) Status

a. Signal Strength: When DMX data is provided to the Control Box acting as an RX , the DMX Status Screen will indicate the CRMX signal strength the Control Box is receiving.

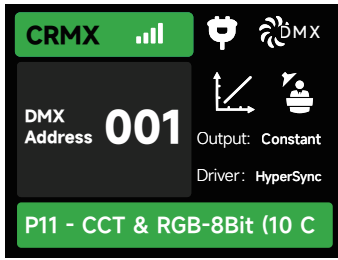

### Signal Strength



b. CRMX Signal is good and DMX data is present.

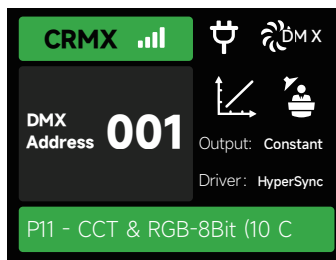

c. No DMX data present.

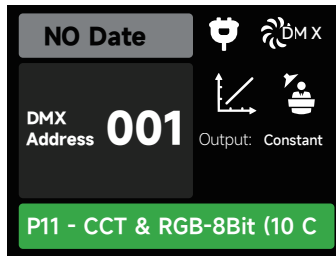

d. The Control Box CRMX RX is out of range of its TX. Check that the TX is powered On and within range.

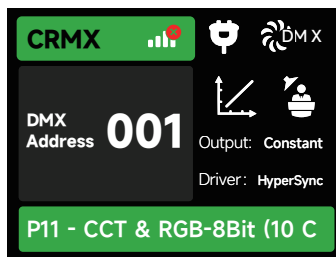

## 2.3.3 Sidus BT Settings

(1) Turn Sidus BT ON or OFF in the Sidus BT settings.

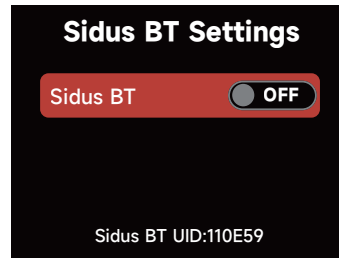
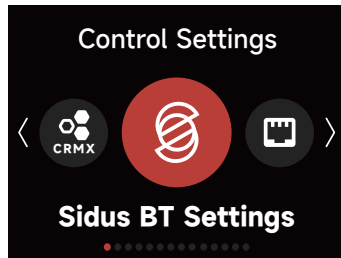

(2) When Sidus BT is "ON": the serial number is displayed here to facilitate connecting with the Sidus Link Pro and Sidus Link Apps. Use Sidus BT Reset to allow your Sidus Link device to connect with a new controller. If Sidus BT fails to reset, a "Reset Failed" warning will pop up before returning to the Sidus BT Reset display.

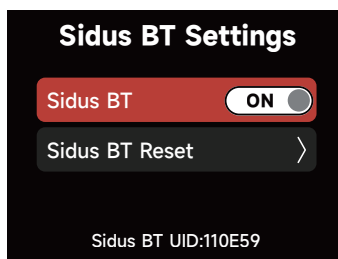
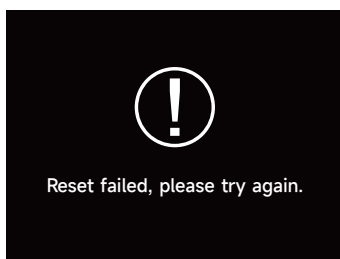
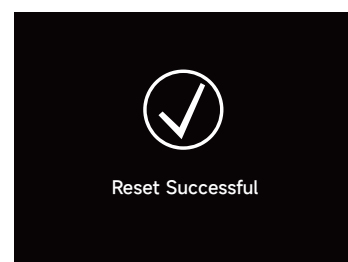
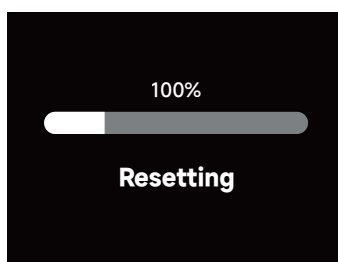
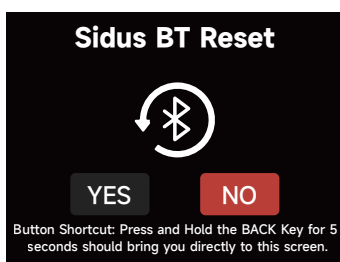

## 2.3.4 Ethernet Settings

View and edit Ethernet Settings

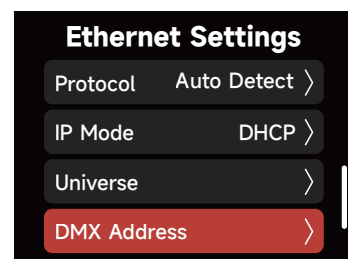
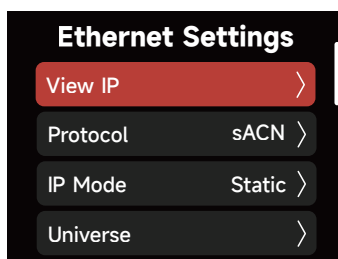
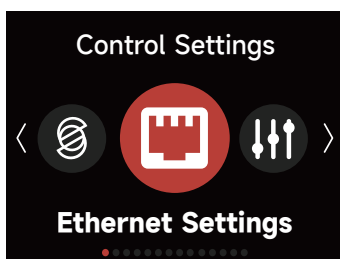

### 2.3.4.1 View IP

View the IP Address, Subnet Mask, Gateway IP and the MAC Address of the Control Box.

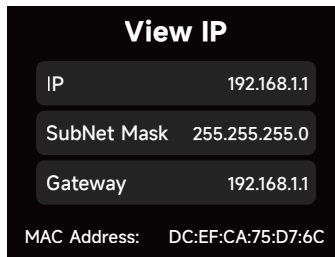

### 2.3.4.2 Protocol

Select the Control Protocol for this Control Box to listen to. Choose between Auto, Art-Net, or sACN.

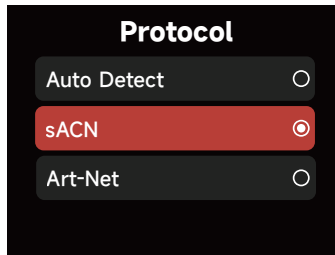

- (a) Automatic: identifies the Control Protocol automatically.
- (b) Art-Net: recognizes the Art-Net Protocol only and ignores sACN.
- (c) sACN: recognizes the sACN Protocol only and ignores Art-Net.

### 2.3.4.3 IP Mode

(1) IP Mode DHCP:

The fixture will automatically receive an IP address from the DHCP server. When in DHCP IP Mode, the IP Address, Subnet Mask and Gateway IP Address cannot be edited.

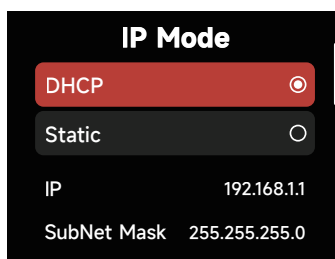

(2) IP Mode Static:

Manually set the IP address, Subnet Mask and the Gateway IP address.

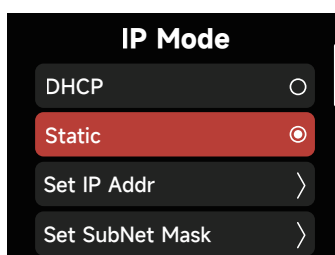

a. In the Presets interface, Select a Preset to edit or apply.

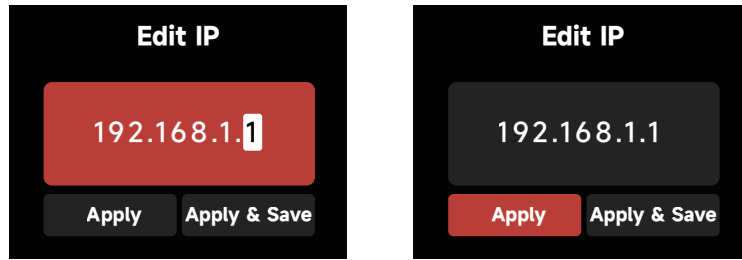

Presets can be edited and saved without applying them to the Control Box's current IP settings.  
(save 10 IP Presets in total)

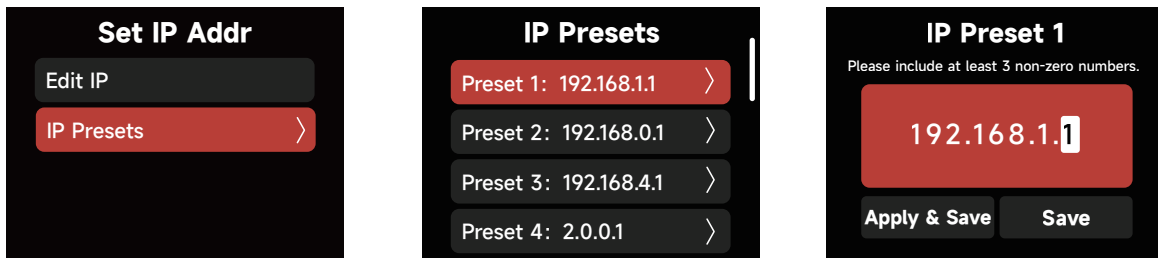

b. Set SubNet Mask

Using the Select Wheel, edit the SubNet Mask information for the Control Box. Use the BACK Button to Exit the interface.

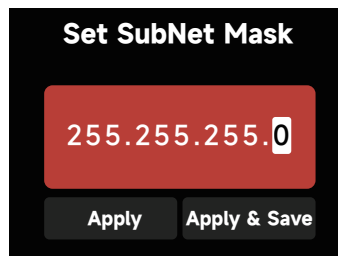

Presets can be saved for future use by selecting "Apply & Save".

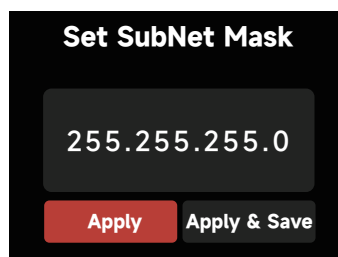

Presets can be edited and saved without applying them to the Control Box's current IP settings.  
(save 10 SubNet Mask Presets in total)

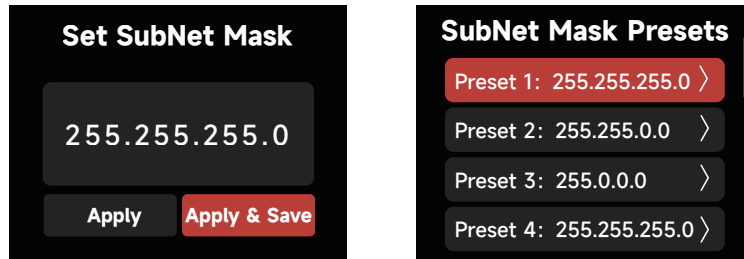

In the Presets interface, Select a Preset to edit or apply.

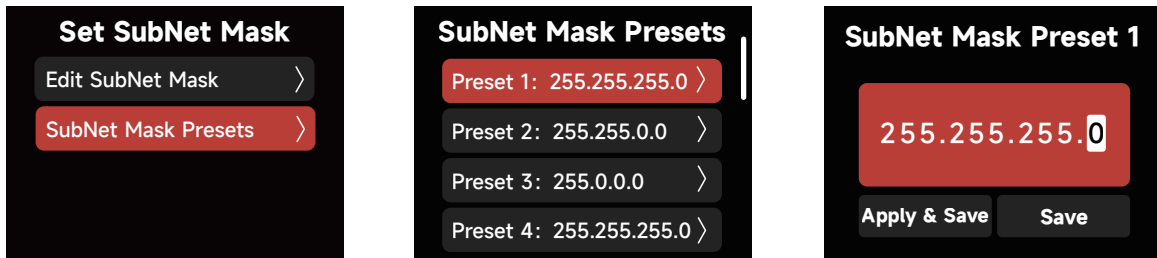

c. In the Presets interface, Select a Preset to edit or apply



Presets can be edited and saved without applying them to the Control Box's current IP settings.

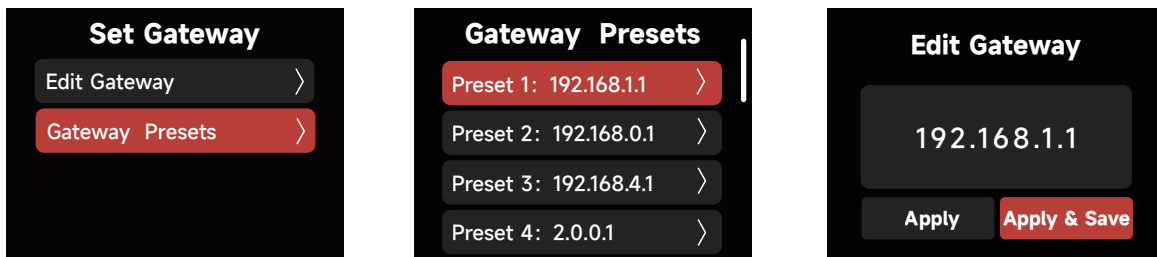

### 2.3.4.4 Universe

Set the Universe of Art-Net and sACN: Art-Net (00000-32767), sACN (00001-63999).

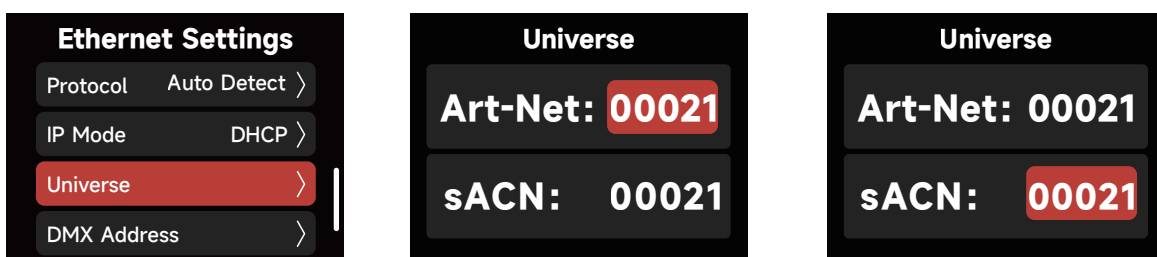

### 2.3.4.5 DMX Address: Set the DMX Address



## 2.4 System Settings

System Settings include: Dimming Curve, Output Settings, White Light Standard, Lead/Follow Mode, High-Speed Mode, Fan Mode, Studio Mode, Screensaver Settings, Language, Product Info, Firmware Update, and Factory Reset options.

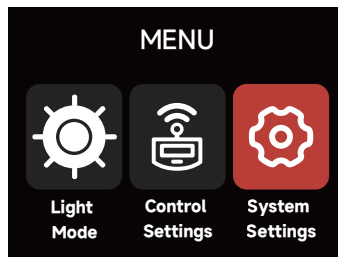

### 2.4.1 Dimming Curve

The following Dimming Curves are available: Linear, Logarithmic, S-Curve and Exponential.

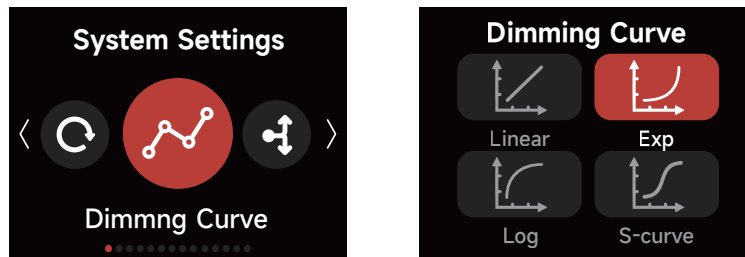

### 2.4.2 Output Settings

1) Constant Output: The lamp's brightness is kept consistent throughout the color temperature range.

2) Max Output: The lamp's brightness is prioritized throughout the color temperature range.

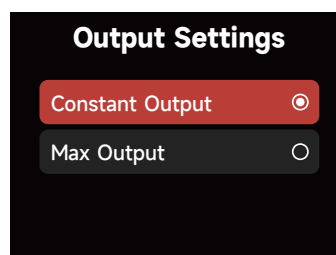



## 2.4.3 White Light Standard

(1) CIE Daylight: meets the sunlight standard

(5000K-10000K, Duv is controlled at 0.0020~0.0040);

(2) Blackbody: meets the blackbody luminescence standard

(Duv is controlled near the blackbody trajectory line).

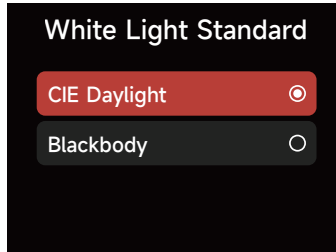

## 2.4.3 Lead/Follow Mode

In this interface, set fixtures as either the Leader or the Follower (Leader/"OFF").

The Leader automatically sends its settings to the Follower fixtures for synchronization.

Batch upgrades of the firmware from a USB drive in the Leader's port is also possible.

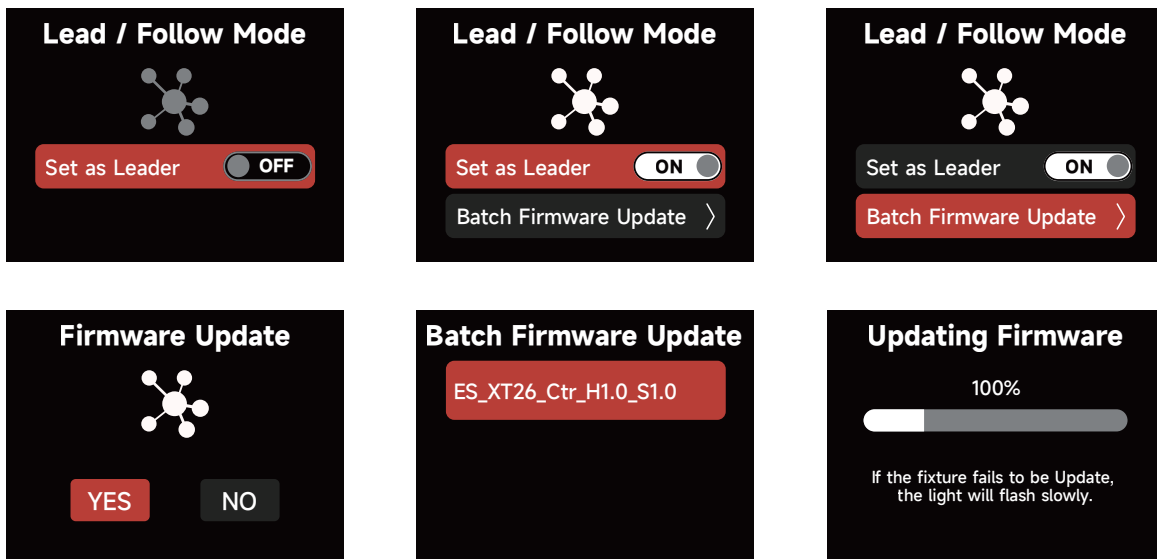

\* The leader fixture should be connected with the followers via DMX to enable this function.

## 2.4.5 High-Speed Mode

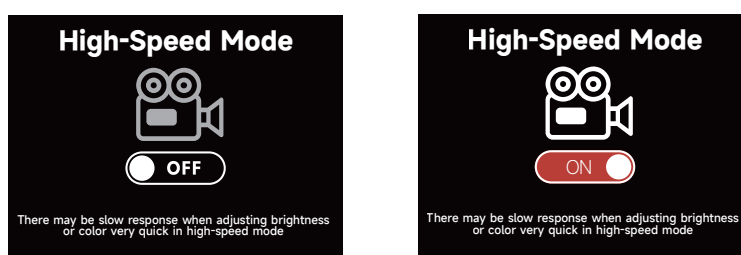

\* If High-Speed Mode is ON:

(1) The lowest intensity output is 20% when utilizing High-Speed Mode.

(2) FX Modes cannot be utilized in High-Speed Mode.

## 2.4.6 Fan Mode

In the System Settings Fan Mode, rotate the Select Wheel and press to choose between Smart, High, Medium, Silent and DMX Controlled Fan Mode.

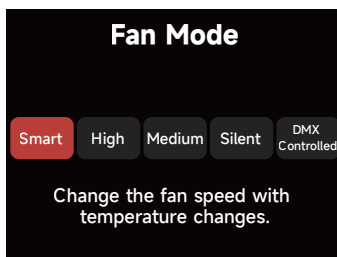

When using the DMX Controlled Fan Mode, the options for the Fan are:

- 1) **Smart:** able to work in  $-20^{\circ}\text{C}/-4^{\circ}\text{F}$  through  $45^{\circ}\text{C}/113^{\circ}\text{F}$  environment, the lamp will automatically adjust the fan speed according to different ambient temperatures.
- 2) **High:** able to work in  $-20^{\circ}\text{C}/-4^{\circ}\text{F}$  through  $45^{\circ}\text{C}/113^{\circ}\text{F}$  environment, fan will maintain its highest speed. In High-Speed Mode, the fan uses the Max Fan setting.
- 3) **Medium:** Capable of working in  $-20^{\circ}\text{C}/-4^{\circ}\text{F}$  through  $35^{\circ}\text{C}/95^{\circ}\text{F}$  environments, the fan uses a medium speed. Medium is the slowest speed possible for Maximum Output.
- 4) **Silent:** When working in an environment of  $-20^{\circ}\text{C}/-4^{\circ}\text{F}$ – $45^{\circ}\text{C}/113^{\circ}\text{F}$ , the fan stays OFF, but the output of the lamp is limited to 75W.
- 5) **DMX Controlled:** Fan listens to the settings sent by the lighting console. See the STORM 1200x DMX Chart for details.

## 2.4.7 Studio Mode

When Studio Mode is enabled (ON), the fixture will power on when connected to live power. When Studio Mode is disabled (OFF), press the power button to power on or power off the fixture.

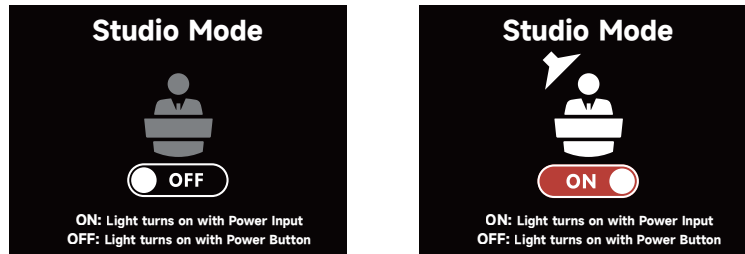

## 2.4.8 Screensaver

Select the Screensaver time and display behavior.



## 2.4.9 Language

Select between English or Chinese and press the Select Wheel to confirm.



## 2.4.10 Product Information

The Firmware Version, SN, Sidus BT ID, Hardware Version and Operating status, can all be checked in the Product Info interface.

- 1) Firmware Version: display the Firmware Version of the Control Box and attached Lamp Head.
- 2) SN: Serial Number
- 3) Sidus BT ID.

4) Hardware Version: display the hardware versions of the Control Box and attached Lamp Head.

5) Operating status: display the Temperature, Control Box and attached Lamp Head Run Time, and any Error Code.

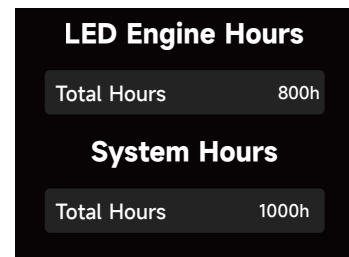
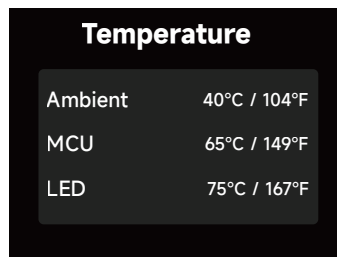
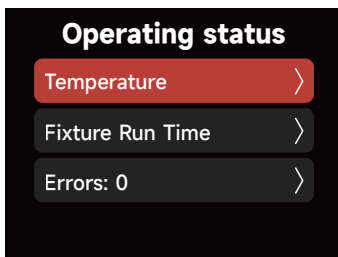
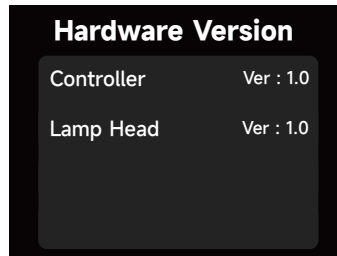
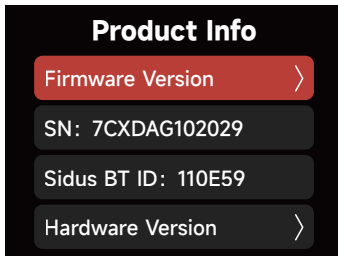

Errors are divided into two categories:

- a. **Serious error:** When a serious error occurs, the fixture cannot be used and will be locked for protection. Please respond to the error according to the fault prompt.
- b. **General error:** When a general error occurs, the fixture is still available for use; enter the Product Info interface to view the error details.

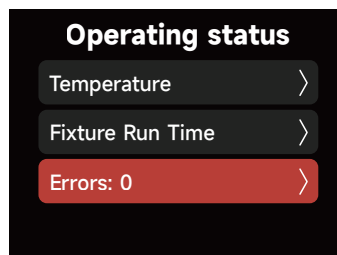

## 2.4.11 Firmware Update

Upgrade the firmware by inserting a USB flash drive with the latest firmware on its root drive into the USB-A port of the Control Box . The current firmware version is also listed in this interface. NOTE: The fixture can also be updated via Sidus Link or Sidus Link Pro with Sidus BT turned ON and a Wi-Fi internet connection on your Sidus Link device. Remember to update both the Control Box and the connected Lamp Head with any new firmware.

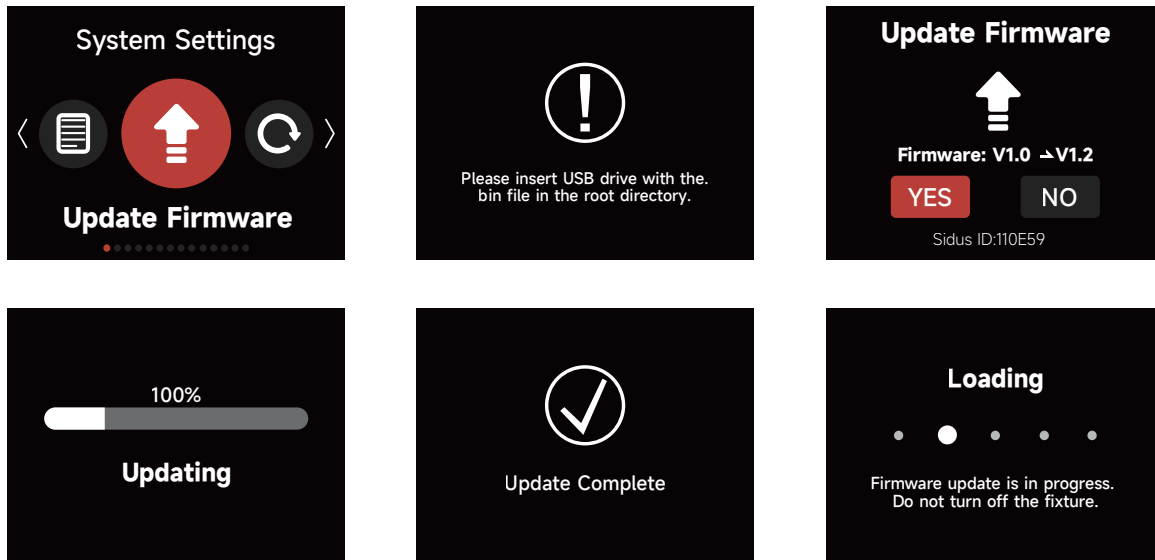

## 2.4.12 Factory Reset

Select "YES" if you wish to Factory Reset the fixture. Select "NO" to cancel.

Choose to Reset CRMX, Reset Sidus BT, Default Language. Hold the Menu button for 5 seconds for a Factory Reset shortcut to appear.

### Factory Settings:

Light Mode	CCT; Color Temperature:3200K
Intensity	0
Output Mode	Maximum Output
Lead/Follow Mode	Off
High-Speed Mode	Off
Screensaver	30 Minutes
White Light Standard	CIE Daylight
Fan Mode	Smart
Dimming Curve	Linear
Studio Mode	On
Fx Mode	Fireworks, Brightness 0%, Color Temperature 3200K, Frequency 5
DMX	Channel 001, Hold Last Look DMX Termination Off, DMX Smooth: Smooth

Ethernet	sACN IP Address: 192.168.2.16 Gateway: 192.168.2.1 Universe: 001
----------	---

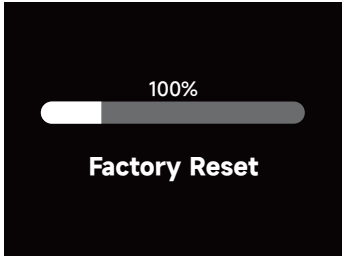
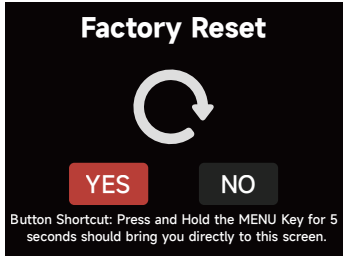
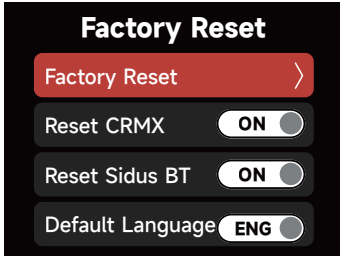

## 2.5 Presets

10 Light Mode Presets can be saved. Choose your settings within the CCT, xy or FX Mode. Then press the PRESET button to open the Preset interface. Select the Preset number to open, replace or delete the Preset.

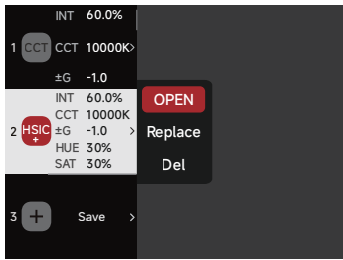

## 3. Control with a DMX Console

Connect the Lighting Console to the STORM 1200x Control Box DMX IN Port:

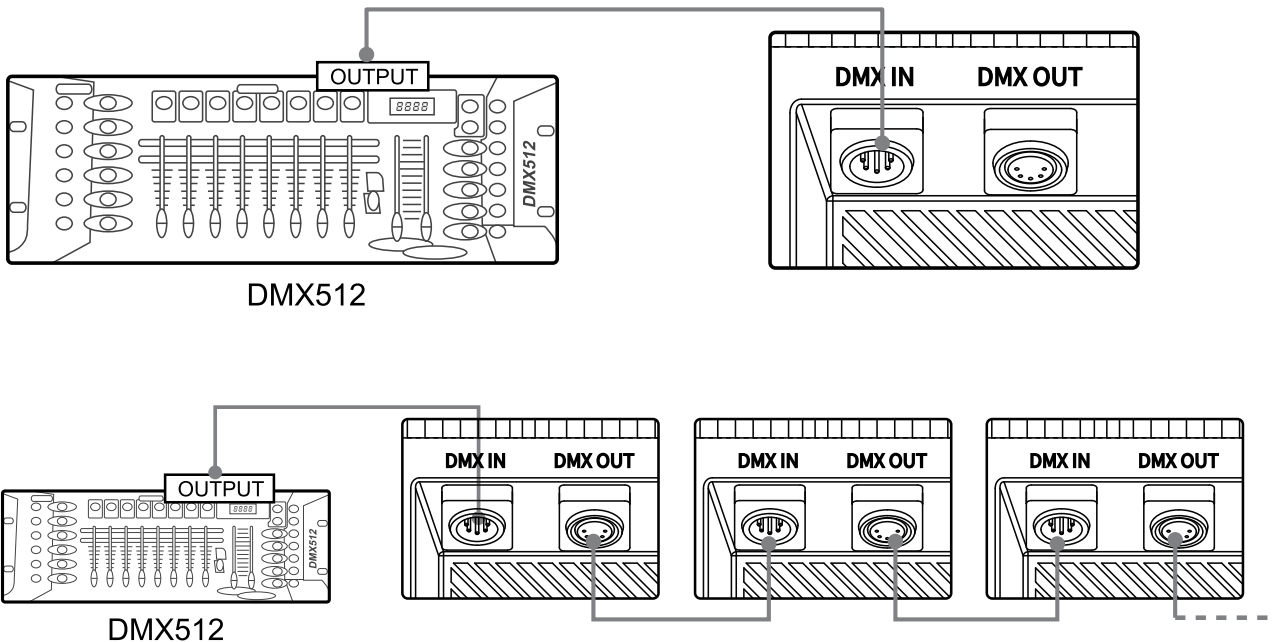

## 4. Controlling via DMX

The STORM 1200x supports several DMX profiles. Please download the DMX Chart on the official website (<https://aputure.com>) to view detailed configurations.

## 5. Sidus Link Pro and Sidus Link

Download Sidus Link and Sidus Link Pro from the iOS App Store or the Google Play Store. Visit [Aputure.com](https://aputure.com) for more details on enhancing the Aputure experience with these Apps.



Get Sidus Link® App  
& Sidus Link Pro®



<https://help.sidus.link/>

# Product Specifications

Power Consumption (Max)	1450W	Output Power (Max)	1200W
Voltage Input Range	100 -240 VAC	Operating Current	6-15.5A
Cooling Method	Air Cooling	Operating Temperature	-20°C ~ 45°C
Color Temperature	2500 K – 10000 K	Weather Resistance Rating	IP65
CQS(5600K)	96	CQS(3200K)	97
SSI(D56)	87	SSI(D32)	87
CRI	95+	TLCI	95+
TM-30 Rf (average value)	95	TM-30 Rg (average value)	100
Control Methods	On-board, Sidus Link & Sidus Link Pro Apps, DMX/RDM, CRMX, sACN/Art-Net		
Bluetooth Wireless Range	≤ 100 m	CRMX Wireless Range	≤ 100 m
Size (length x width x height)	Lamp Head (without yoke)	33.46 x 23.17 x 25.08cm / 13.17 x 9.12 x 9.87 in	
	Lamp Head (with yoke)	33.46 x 33.8 x 55.73cm / 13.17 x 13.31 x 21.94 in	
	Control Box	13.58 x 20 x 34.35cm / 5.35 x 7.87 x 13.52 in	
Weight	Lamp Head	9.8 kg/21.6lbs	
	Control Box	6.12 kg/13.5 lbs	

\* Damage to the Lamp Head or Control Box from moisture is not covered under the warranty. If the STORM 1200x is used in a heavy rain, it is recommended to use the tilt angle range of the lamp head as shown below:

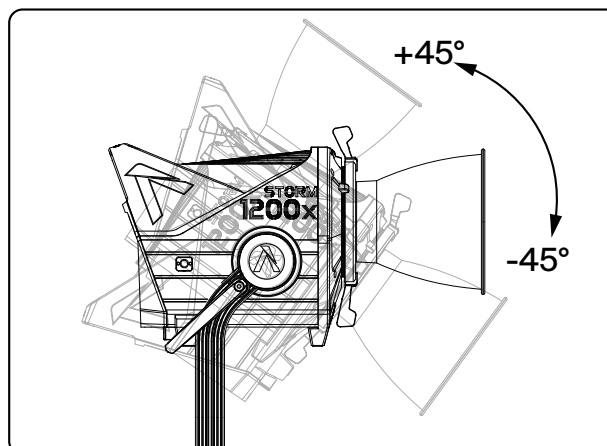



# Photometrics

Normal mode							
CCT	Distance	Bare light	Reflectors			CF12 Fresnel lens tube	
			BM7815	BM7830	BM7845	15°	45°
2500K	2m	14600lux	162000lux	80000lux	35500lux	145000lux	28000lux
		1357fc	15056fc	7435fc	3299fc	13476fc	2602fc
	3m	6570lux	74000lux	32200lux	15300lux	64300lux	13000lux
		611fc	6877fc	2993fc	1422fc	5976fc	1208fc
	5m	2510lux	25600lux	10900lux	5420lux	22400lux	4760lux
		233fc	2379fc	1013fc	505fc	2082fc	442fc
7m	1270lux	12800lux	5430lux	2770lux	11300lux	2460lux	
	118fc	1190fc	505fc	257fc	1050fc	229fc	
3200K	2m	18700lux	206000lux	102000lux	45400lux	185000lux	35800lux
		1738fc	19145fc	9480fc	4219fc	17193fc	3327fc
	3m	8370lux	94600lux	41100lux	19500lux	82500lux	16500lux
		778fc	8792fc	3820fc	1812fc	7667fc	1533fc
	5m	3170lux	30900lux	13800lux	6910lux	28600lux	6070lux
		295fc	2872fc	1283fc	642fc	2658fc	564fc
7m	1610lux	16300lux	6920lux	3510lux	14500lux	3160lux	
	150fc	1515fc	643fc	326fc	1348fc	294fc	
4300K	2m	19000lux	212000lux	105000lux	47000lux	192000lux	37000lux
		1766fc	19703fc	9758fc	4368fc	17844fc	3439fc
	3m	8620lux	97400lux	42400lux	20100lux	85300lux	17100lux
		801fc	9052fc	3941fc	1868fc	7928fc	1589fc
	5m	3280lux	33600lux	14300lux	7130lux	29600lux	6280lux
		305fc	3123fc	1329fc	663fc	2751fc	584fc
7m	1670lux	16800lux	7150lux	3630lux	15000lux	3240lux	
	155fc	1561fc	664fc	337fc	1394fc	301fc	
5600K	2m	18900lux	209000lux	104000lux	46000lux	190000lux	36500lux
		1757fc	19424fc	9665fc	4275fc	17658fc	3392fc
	3m	8490lux	96100lux	41800lux	19800lux	84400lux	16900lux
		789fc	8931fc	3885fc	1840fc	7844fc	1571fc
	5m	3230lux	33300lux	14100lux	7070lux	29300lux	6230lux
		300fc	3095fc	1310fc	657fc	2723fc	579fc
7m	1640lux	16600lux	7050lux	3580lux	14800lux	3210lux	
	152fc	1543fc	655fc	333fc	1375fc	298fc	

Continued table :

Normal mode							
CCT	Distance	Bare light	Reflectors			CF12 Fresnel lens tube	
			BM7815	BM7830	BM7845	15°	45°
6500K	2m	18600lux	206000lux	102000lux	45400lux	187000lux	36000lux
		1729fc	19145fc	9480fc	4219fc	17379fc	3346fc
	3m	8370lux	94700lux	41200lux	19500lux	83300lux	16700lux
		778fc	8801fc	3829fc	1812fc	7742fc	1552fc
	5m	3180lux	32700lux	13900lux	6910lux	28900lux	6120lux
		296fc	3039fc	1292fc	642fc	2686fc	569fc
7m	1620lux	16300lux	6950lux	3530lux	14600lux	3170lux	
	151fc	1515fc	646fc	328fc	1357fc	295fc	
7500K	2m	18300lux	202000lux	100000lux	44500lux	184000lux	35300lux
		1701fc	18773fc	9294fc	4136fc	17100fc	3281fc
	3m	8200lux	92800lux	40400lux	19100lux	81900lux	16300lux
		762fc	8625fc	3755fc	1775fc	7612fc	1515fc
	5m	3120lux	32000lux	13600lux	6800lux	28400lux	6010lux
		290fc	2974fc	1264fc	632fc	2639fc	559fc
7m	1580lux	16000lux	6800lux	3440lux	14300lux	3100lux	
	147fc	1487fc	632fc	320fc	1329fc	288fc	
10000K	2m	17400lux	192000lux	95000lux	42300lux	175000lux	33600lux
		1617fc	17844fc	8829fc	3931fc	16264fc	3123fc
	3m	7790lux	87900lux	38400lux	18200lux	77800lux	15600lux
		724fc	8169fc	3569fc	1691fc	7230fc	1450fc
	5m	2960lux	30400lux	12900lux	6470lux	27000lux	5720lux
		275fc	2825fc	1199fc	601fc	2509fc	532fc
7m	1510lux	15200lux	6460lux	3280lux	13700lux	2960lux	
	140fc	1413fc	600fc	305fc	1273fc	275fc	

\*The brightness data is average data, and the brightness of different lamps may vary slightly.

High-speed photography mode							
CCT	Distance	Bare light	Reflectors			CF12 Fresnel lens tube	
			BM7815	BM7830	BM7845	15°	45°
2500K	2m	14800lux	165000lux	81500lux	36200lux	148000lux	28500lux
		1375fc	15335fc	7574fc	3364fc	13755fc	2649fc
	3m	6690lux	75800lux	32900lux	15600lux	65500lux	13200lux
		622fc	7045fc	3058fc	1450fc	6087fc	1227fc
	5m	2550lux	26100lux	11100lux	5550lux	22800lux	4840lux
		237fc	2426fc	1032fc	516fc	2119fc	450fc
7m	1290lux	13000lux	5530lux	2820lux	11500lux	2500lux	
	120fc	1208fc	514fc	262fc	1069fc	232fc	
3200K	2m	19000lux	211000lux	104000lux	46200lux	190000lux	36700lux
		1766fc	19610fc	9665fc	4294fc	17658fc	3411fc
	3m	8570lux	97100lux	42200lux	20000lux	84500lux	16900lux
		796fc	9024fc	3922fc	1859fc	7853fc	1571fc
	5m	3260lux	33400lux	14200lux	7100lux	29400lux	6220lux
		303fc	3104fc	1320fc	660fc	2732fc	578fc
7m	1660lux	16700lux	7100lux	3610lux	14800lux	3220lux	
	154fc	1552fc	660fc	336fc	1375fc	299fc	
4300K	2m	21500lux	239000lux	118000lux	52600lux	216000lux	41600lux
		1998fc	22212fc	10967fc	4888fc	20074fc	3866fc
	3m	9690lux	110000lux	47800lux	22600lux	96200lux	19200lux
		901fc	10223fc	4442fc	2100fc	8941fc	1784fc
	5m	3690lux	37800lux	16000lux	8020lux	33300lux	7050lux
		343fc	3513fc	1487fc	745fc	3095fc	655fc
7m	1870lux	18900lux	8030lux	4080lux	16800lux	3640lux	
	174fc	1757fc	746fc	379fc	1561fc	338fc	
5600K	2m	21500lux	238000lux	118000lux	52400lux	216000lux	41600lux
		1998fc	22119fc	10967fc	4870fc	20074fc	3866fc
	3m	9670lux	110000lux	47600lux	22500lux	96100lux	19200lux
		899fc	10223fc	4424fc	2091fc	8931fc	1784fc
	5m	3690lux	37700lux	16000lux	8010lux	33300lux	7050lux
		343fc	3504fc	1487fc	744fc	3095fc	655fc
7m	1870lux	18800lux	8020lux	4070lux	16800lux	3640lux	
	174fc	1747fc	745fc	378fc	1561fc	338fc	

Continued table :

High-speed photography mode							
CCT	Distance	Bare light	Reflectors			CF12 Fresnel lens tube	
			BM7815	BM7830	BM7845	15°	45°
6500K	2m	21300lux	236000lux	117000lux	52000lux	214000lux	41300lux
		1980fc	21933fc	10874fc	4833fc	19888fc	3838fc
	3m	9570lux	109000lux	47100lux	22300lux	95600lux	19000lux
		889fc	10130fc	4377fc	2072fc	8885fc	1766fc
	5m	3640lux	37300lux	15900lux	7920lux	33100lux	6990lux
		338fc	3467fc	1478fc	736fc	3076fc	650fc
7m	1850lux	18700lux	7940lux	4030lux	16700lux	3610lux	
	172fc	1738fc	738fc	375fc	1552fc	336fc	
7500K	2m	20800lux	230000lux	114000lux	50600lux	209000lux	40300lux
		1933fc	21375fc	10595fc	4703fc	19424fc	3745fc
	3m	9320lux	106000lux	46000lux	21700lux	93300lux	18600lux
		866fc	9851fc	4275fc	2017fc	8671fc	1729fc
	5m	3550lux	36400lux	15500lux	7730lux	32300lux	6820lux
		330fc	3383fc	1441fc	718fc	3002fc	634fc
7m	1800lux	18200lux	7740lux	3930lux	16300lux	3530lux	
	167fc	1691fc	719fc	365fc	1515fc	328fc	
10000K	2m	17800lux	197000lux	98000lux	43500lux	180000lux	35000lux
		1654fc	18309fc	9108fc	4043fc	16729fc	3253fc
	3m	8010lux	90900lux	39400lux	18700lux	80400lux	16000lux
		744fc	8448fc	3662fc	1738fc	7472fc	1487fc
	5m	3050lux	31200lux	13300lux	6660lux	27800lux	5870lux
		283fc	2900fc	1236fc	619fc	2584fc	546fc
7m	1550lux	15600lux	6650lux	3370lux	14100lux	3030lux	
	144fc	1450fc	618fc	313fc	1310fc	282fc	

*\*The brightness data is average data, and the brightness of different lamps may vary slightly.*

# Safety Instructions

When using this product, basic safety precautions should always be followed, including:

1. Read and understand all instructions before using the fixture.
2. Close supervision is necessary when any fixture is used by or near children. Do not leave the fixture unattended while in use.
3. Care must be taken as burns can occur from touching hot surfaces.
4. Do not operate the fixture if any cord is damaged, or if the fixture has been dropped or damaged, until it has been examined by qualified service personnel.
5. Position any power cables such that they will not be tripped over, pulled, or put into contact with hot surfaces.
6. If an extension cord is necessary, a cord with an amperage rating at least equal to that required by the fixture should be used. Cords rated for less amperage will overheat.
7. Always unplug the lighting fixture from the electrical outlet before cleaning and servicing, or when not in use. Never yank the cord to remove the plug from the outlet.
8. Let the lighting fixture cool completely before storing. Unplug the cables from the lighting fixture and store them in assigned spaces of the carrying case (if being used).
9. Do not immerse this fixture in water or any other liquid to avoid electric shock.
10. Do not disassemble the fixture to avoid the risk of fire or electric shock. Contact [cs@aputure.com](mailto:cs@aputure.com) or take the lighting fixture to qualified service personnel when service or repair is required. Incorrect reassembly may cause electric shock when the lighting fixture is in use.
11. Using any accessory attachment not recommended by the manufacturer may increase the risk of fire, electric shock or injury to any persons operating the fixture.
12. Power this fixture by connecting it to a grounded outlet.
13. Remove the Protective Cover before use.
14. Do not block the ventilation openings or look at the LED light source directly when it is powered on. Do not touch the LED light source in any condition.
15. Do not place the product near combustible and volatile solvents to avoid product damage.
16. Use a soft and dry cloth to clean the device.
17. Ensure all the ports and plugs are completely dry when using the fixture in wet environments to avoid short circuit or electric shock.



18. Service and maintenance should only be carried out by authorized service personnel. Any malfunctions caused by unauthorized disassembly are not covered by the warranty. The user may pay for service and maintenance.

19. When hanging the fixture overhead, always ensure an extra safety measure has been attached -such as safety chains- that is certified for the weight of the fixture. We recommend only using the original Aputure cable accessories. Please note that any malfunctions caused by using unauthorized accessories are not covered by the warranty. The user may pay for service and maintenance. When hanging the fixture overhead, always ensure an extra safety measure has been attached -such as safety chains- that is certified for the weight of the fixture.

20. This product is certified by RoHS, CE, KC, PSE, and FCC. Please operate the product in full compliance with relevant country's standards. Any malfunctions caused by incorrect use are not covered by the warranty. The user may pay for service and maintenance.

21. The User's Manual was formulated based on rigorous tests performed by the Company. No further notice will be given in the event of any change in its design and specifications.

## FCC Declaration of Conformity

### WARNING

Changes or modifications to this product that are not expressly approved by the manufacturer are prohibited and voids the user warranty.

### ATTENTION

This equipment has been tested and found to comply with the limits for a Class B digital device, pursuant to Part 15 of the FCC Rules. These limits are designed to provide reasonable protection against harmful interference in a residential installation. This equipment generates, uses, and can radiate radio frequency energy and, if not installed and used in accordance with the instructions, may cause harmful interference to radio communications. However, there is no guarantee that interference will not occur in a particular installation.

If this equipment does cause harmful interference to radio or television reception, which can be determined by turning the equipment off and on, the user is encouraged to try to reorient or relocate the receiving antenna.

- Increase the separation between the equipment and receiver.
- Plug the device into the socket of a different circuit than the socket that the receiver is plugged into.
- Consult the dealer or experienced radio/TV technician for assistance.

### RF Statement

This device has been evaluated to meet general RF exposure requirements.

# Disclaimer

Please read the Product Manual before usage to ensure that you have fully understood the instructions and can correctly operate the device. After your reading, please keep the Product Manual properly for reference in the future. If you fail to operate the product correctly, you may get injured seriously or harm others seriously, or damage the product and result in your property damage. Your operation of the product will be deemed that you have understood, recognized and accepted all clauses and content of this document. Users undertake to be responsible for their behaviors and the consequences accordingly. Aputure will not be responsible for all losses arising from users' operation of this product not in accordance with the User's Manual.

The Company reserves the right for the final explanation of this document and all documents relating to the product on the premise of compliance with laws and regulations. No further notice will be given in the event of any update, revision or termination. Please access the official website of Aputure for the up-to-date product information.